

ASSI[®] Instrument Cases, Racks and Baskets



For complete selection of instrument cases see inside pages

accurate surgical & scientific instruments corporation

1-800-645-3569 (NEW YORK OFFICE) **1-800-255-9378** (WEST COAST OFFICE)

Info: assi@accuratesurgical.com • Orders: orders@accuratesurgical.com • www accuratesurgical.com

Note: Not all ASSI products shown in our literature or on our website are available for sale in Canada.

Instrument Cases

MICRO INSTRUMENT CASES

- All single and double cases are constructed of stainless steel with very fine perforations. (Covers are hinged for easy removal.)
- Silicone mats and cushions hold instrument securely.
- Safe locking system prevents accidental opening.



AS588C
8½" x 12" x 1¼"

AS594C
10½" x 15" x 1½"

Above cases have
silicone finger mats below,
silicone cushions above.

SINGLE
CASES



AS590C
6" x 10½" x 1¼"
Silicone finger mats below,
silicone cushions above.

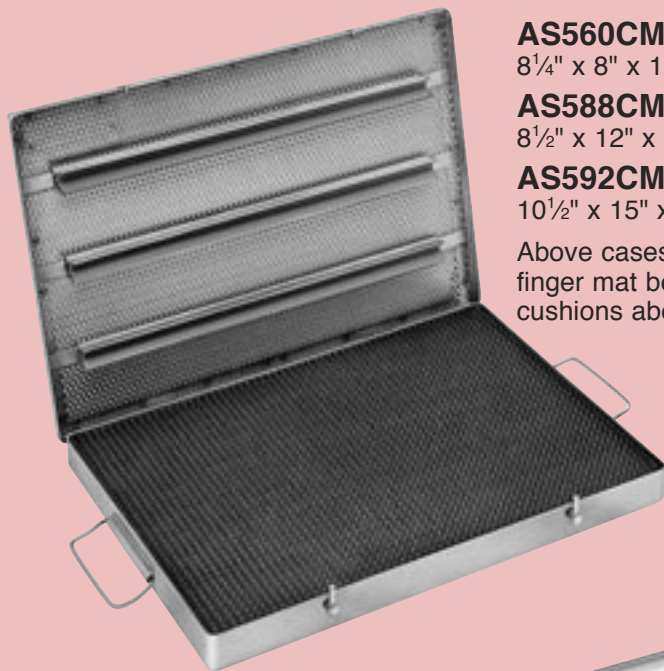

AS560CM
8 $\frac{1}{4}$ " x 8" x 1 $\frac{1}{4}$ "

AS588CM
8 $\frac{1}{2}$ " x 12" x 1 $\frac{1}{4}$ "

AS592CM
10 $\frac{1}{2}$ " x 15" x 1 $\frac{1}{4}$ "

Above cases have full silicone
finger mat below, silicone
cushions above.



AS592C
10 $\frac{1}{2}$ " x 15" x 1 $\frac{1}{4}$ "
Silicone rubber grooved
cushions below, silicone
cushions above.



AS570C
4" x 8" x $\frac{5}{8}$ "

AS573C
6 $\frac{1}{4}$ " x 10 $\frac{1}{4}$ " x 1"

AS575C
8" x 12" x 1"

AS578C
8" x 14" x 1"

Above cases have silicone finger mat below.

Instrument Cases

MICRO INSTRUMENT CASES

**DOUBLE
CASES**
WITH REMOVABLE INSERT TRAY

AS590DC

6" x 10½" x 2½"

Silicone finger mats below,
silicone cushions above.



AS592DC

10½" x 15" x 2½"

Silicone rubber grooved
cushions below, silicone
cushions above.

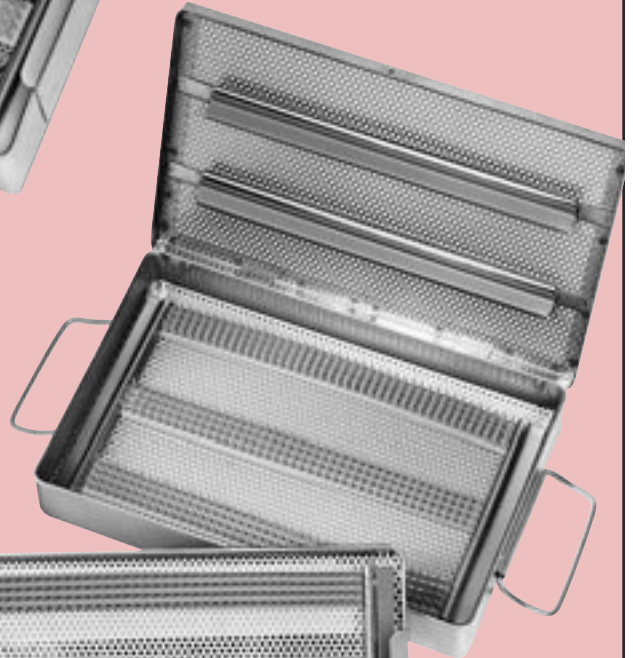

AS588DC

8½" x 12" x 2½"

AS594DC

10½" x 15" x 2½"

Above cases have silicone finger mats below,
silicone cushions above.

AS1143DC

10½" x 20" x 2½"

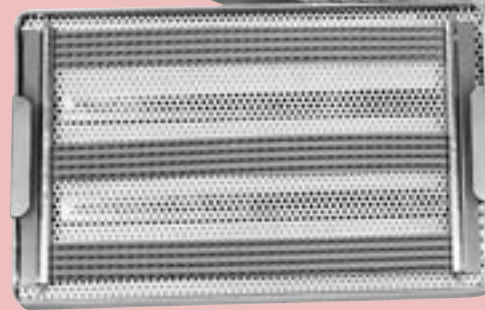

accurate surgical & scientific instruments corporation

1-800-645-3569 (NEW YORK OFFICE)

1-800-255-9378 (WEST COAST OFFICE)

It is strongly recommended that an instrument case containing an instrument rack be your first purchase. This will ensure the proper safe-keeping which your instruments deserve.

Our stainless steel instrument cases are designed to hold the range of interchangeable instrument racks available to order in G7 Catalog on page 471.

THE CASE FOR EXCELLENCE...

Would you trust your precision microsurgical instruments in anything less? Forged from the finest stainless steel, designed for convenience and total protection, this is the ultimate instrument storage and case.

- *Unique silicone rubber finger mat protects the delicate tips of microsurgical instruments.*
- *Convenient detachable top.*



ASSI.ICFM2326
Instrument Storage Case 26x24x2.5cm.

Instrument Cases

ASSI® "SEE-THRU" INSTRUMENT CASES

- **Compact design** allows easy transportation to surgical site.
- **Transparent lid** permits easy instrument identification and inspection.
- **Two-level design** delivers maximum capacity in minimal space.
- **Perforated finger mats** provide maximum protection for instruments.

AS1150C

10" x 6" x 1 1/2"
Base, lid, and 1 mat.
Holds approximately 10 instruments.

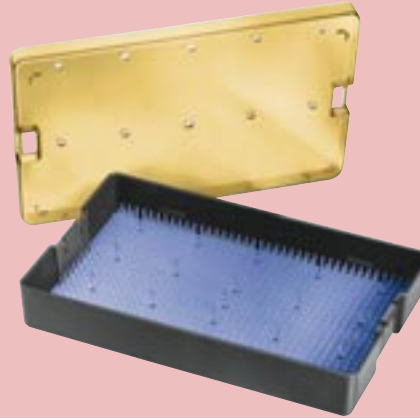

AS1150L

Lid only for AS1150C. See thru instrument case.

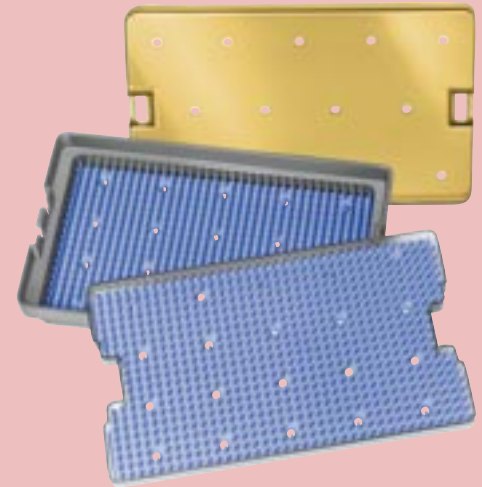

AS1144C

9 1/2" x 5 1/2" x 1 1/2"
Tray insert: 1/2" deep
Base, Lid, Tray Insert, 2 Mats.
Holds approximately 20 instruments.

AS1134C

9 1/2" x 5 1/2" x 1"
Base, Lid, and Mat.
Holds approximately 10 instruments.

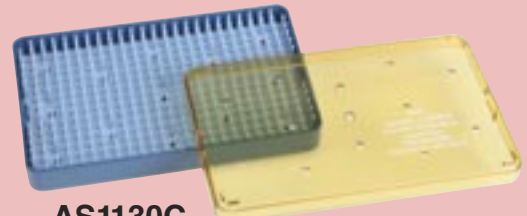
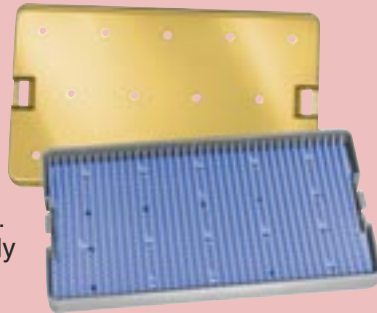

AS1130C

4" x 6" x 1"
Base, Lid, and Mat.

AS1134CW/M

9 1/2" x 5 1/2" x 1"
See-Thru Instrument Case,
w/ Lid and base w/o mat



SILICONE MATS 6" x 10"

AS1134M

Replacement for AS1134C

AS1144M

Replacement for AS1144C
(Base Mat)

AS1150M

Replacement for AS1150C

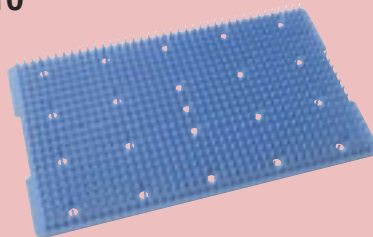

AS1143C

9 1/2" x 5 1/2" x 1 1/2"
Base and Lid.



ASSI® "SEE-THRU" INSTRUMENT CASES



AS1165C
11" x 7" x 1³/₈"
See-thru case.
Base, lid, tray insert
and 2 mats.



AS1170C
11" x 7" x 1³/₈"
See-thru case.
Base, lid and 1 mat.



ASSI.SYST
9.75" x 5.75" X 1"
Base, lid, and Tray Insert.
For Microvascular Clamps



AS1160C
11" x 7" x 5⁵/₈"
See-thru case.
Base, lid and 1 mat.

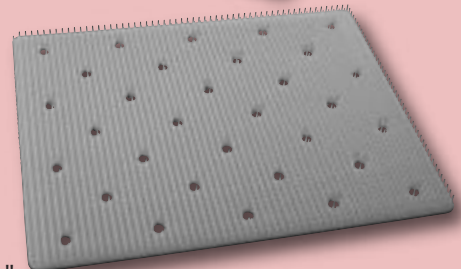

AS1202M
11" x 14" x 3³/₄"
Silicone finger mat with perforations.



AS2037M
19" x 14" x 1¹/₄"
Full size silicone finger mat
without perforations.



AS3293C
11" x 14" x 3³/₄"
See-Thru Medium Scope Case,
15¹/₂" x 2³/₄" x 1.38 inch,
Holds 1 Scope 1-10mm Dia,
Up to 15.5 inch long

AS3323C
11" x 14" x 3³/₄"
See-Thru Large Scope Case,
18" x 2³/₄" x 1.38 inch,
Holds 1 Scope 1-10mm Dia,
Up to 18 inch long

Instrument Clamp Cases

ASSI® CLAMP CASES

For holding vessel clips, hooks and clamps.

- Durable, stainless steel construction with ventilating holes for autoclave.
- Clamp cases are available in 2 sizes:
ASSI.CB2, Large, with 12 compartments
ASSI.CB3, Medium, with 7 compartments.
- Clamp box is available with a single compartment.

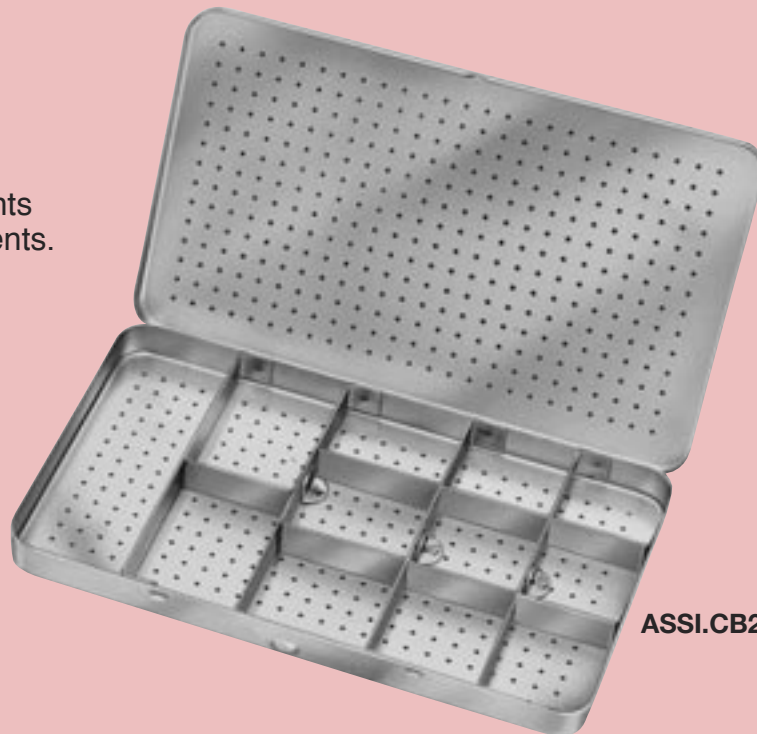

ASSI.CB2

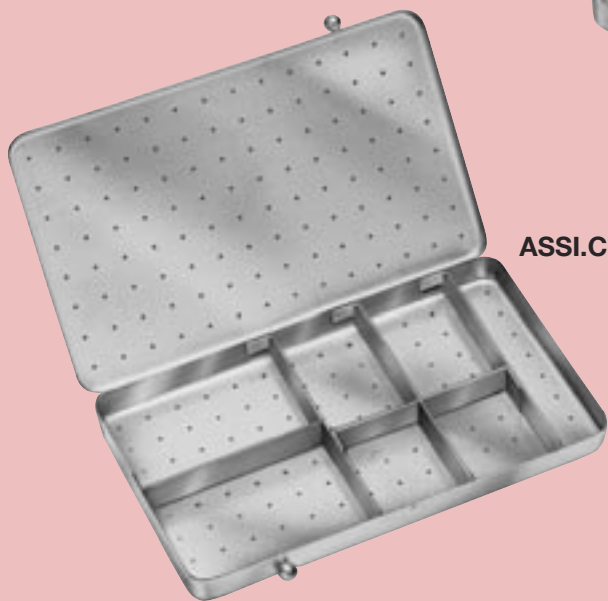

ASSI.CB3

ASSI.CB3

Clamp case with 7 compartments
(150 x 95 x 13mm)

ASSI.CB2

Clamp case with 12 compartments
(210 x 125 x 17mm)

ASSI® CLAMP BOX

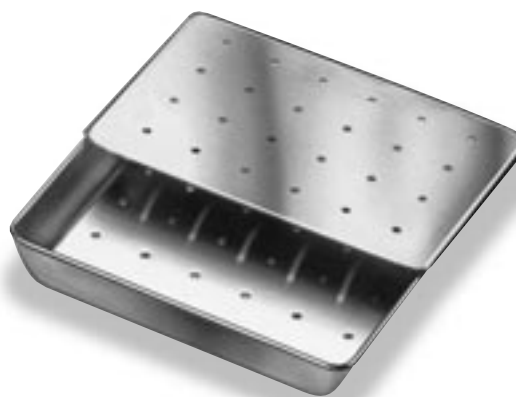

ASSI.CB1

Clamp box with single compartment
(65 x 42 x 10.4mm)

ASSI.ICF718

Instrument Case for four 15cm instruments, complete with **Instrument Rack**, without Clamp Box. 7 x 18cm.

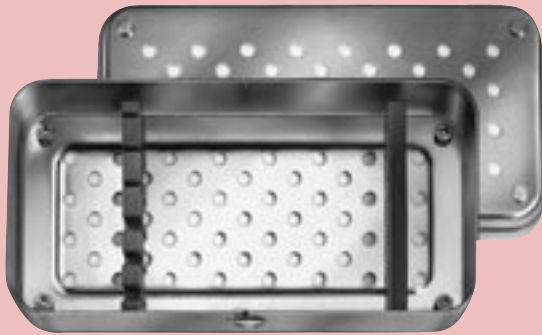
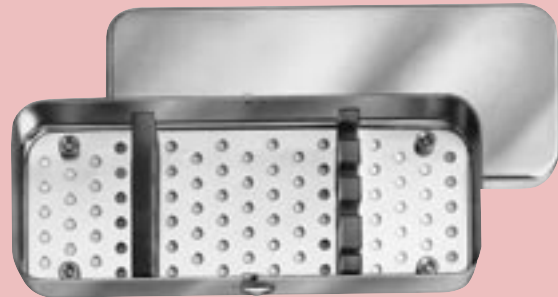

ASSI.ICF1020

Instrument Case with filter for 6 instruments, 18cm, complete with **Instrument Rack**, without Clamp Box.

ASSI.SIC1220

Instrument Case 12x20cm for up to 7 instruments of 18cm length, complete with **Silicone Instrument Rack**, without Clamp Box.

ASSI.ICN1220

1 box 12 x 20cm.
Holds 12 nerve forceps and 1 blade holder.



ASSI® Instrument Rack

- “Stay-Cool”
Silicone Handles
For Easy Gripping
- Silicone Holding Bars
For 9 Round-Handle
Instruments
- Silicone Clamp Box
Holding Bar
- Silicone Rubber Finger Mat
For Instrument Management

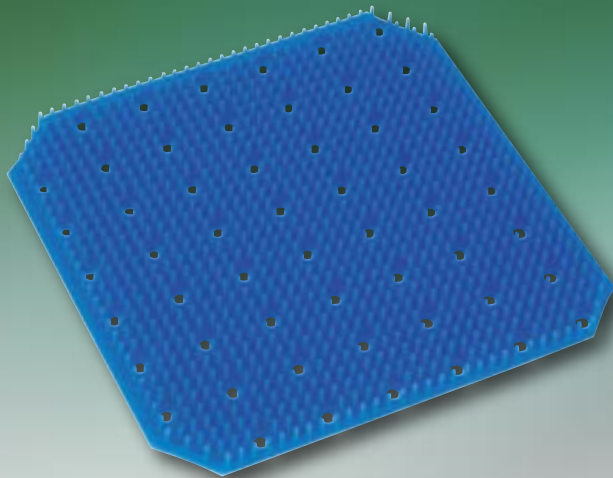
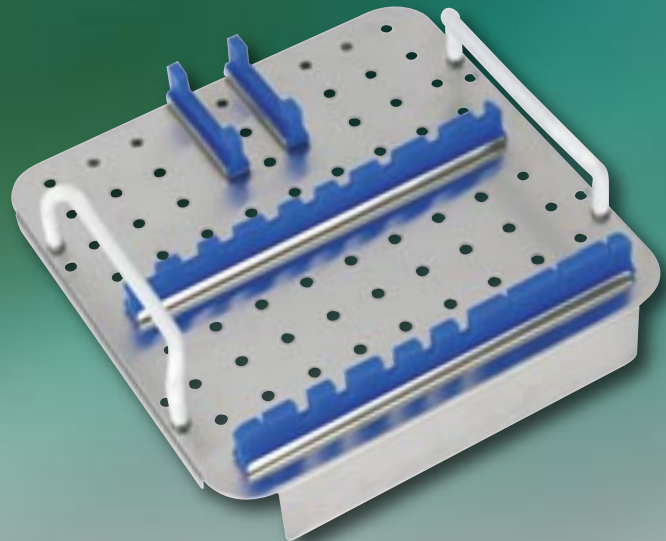
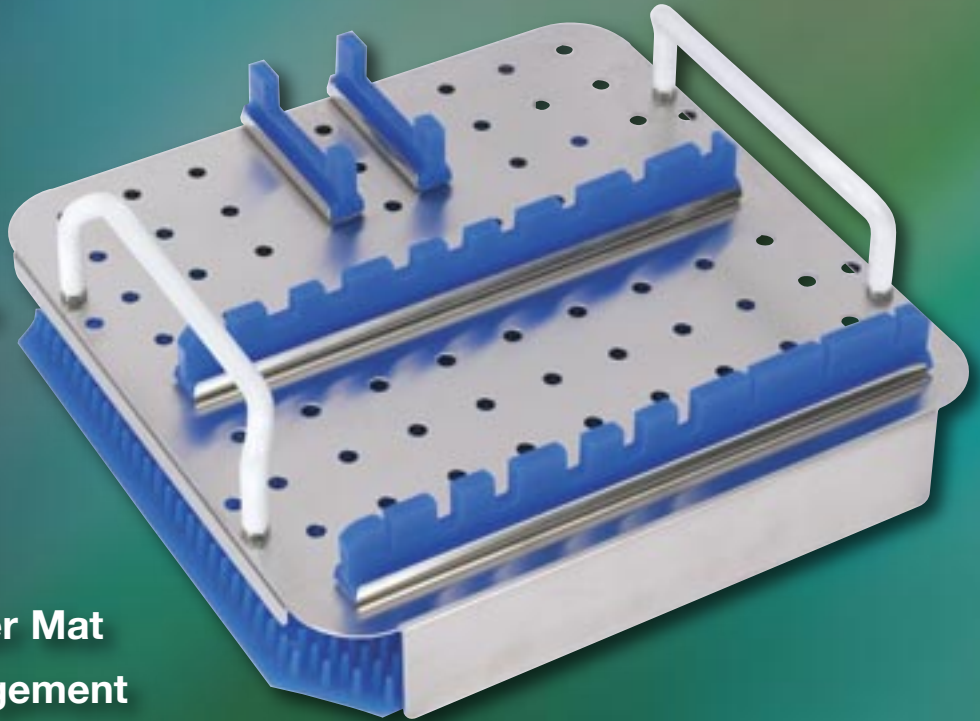

ASSI.FM2424 Silicone Rubber Finger Mat

ASSI.R2424 Instrument Rack

- Holds Instrument Securely
- Removable As Needed
- Stainless Steel Construction



accurate surgical & scientific instruments corporation

300 Shames Drive, Westbury, NY 11590

800.645.3569 516.333.2570 fax: 516.997.4948 west coast: 800.255.9378

Info: assi@accuratesurgical.com • Orders: orders@accuratesurgical.com

www.accuratesurgical.com

Not all ASSI products shown in our literature or on our website are available for sale in Canada

INSTRUMENT BASKETS

ASSI.ICN913

1 box 9x13cm.
Holds 6 nerve forceps
and 1 blade holder.



INSTRUMENT CASES WITHOUT RACKS *(Racks featured on next page)*

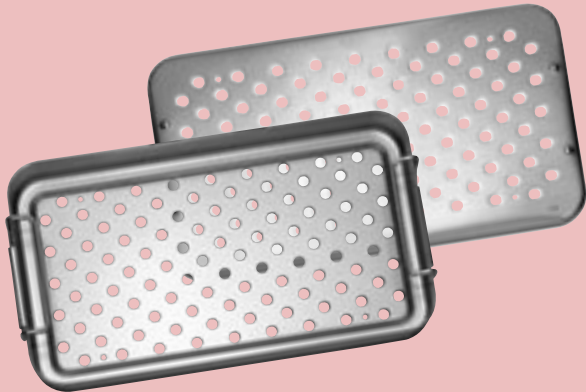

ASSI.ICL1323

Instrument case **without Instrument Rack**,
13 x 23cm, holds 8 instruments. Accepts any of the following
ASSI® Instrument Racks: ICI15CB, ICI18, ICI53CB, or ICI15.
(Holds 1 Instrument Rack.)

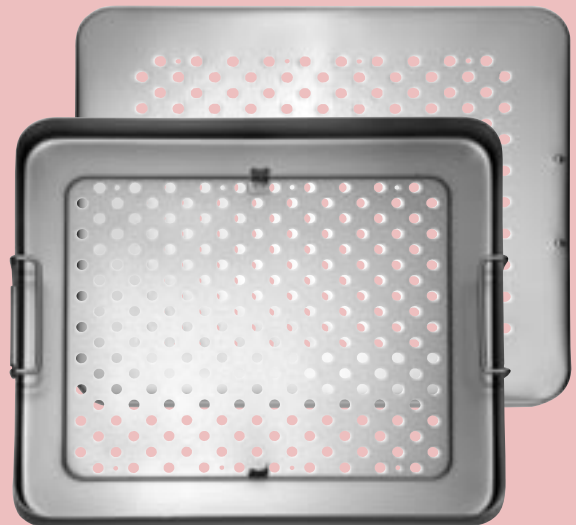

ASSI.ICE2427

Instrument case **without Instrument Rack**,
24 x 27cm, holds 16 instruments. Accepts any 2 of
the following ASSI® Instrument Racks: ICI15CB,
ICI18, ICI53CB, or ICI15.
(Holds 2 Instrument Racks side by side.)

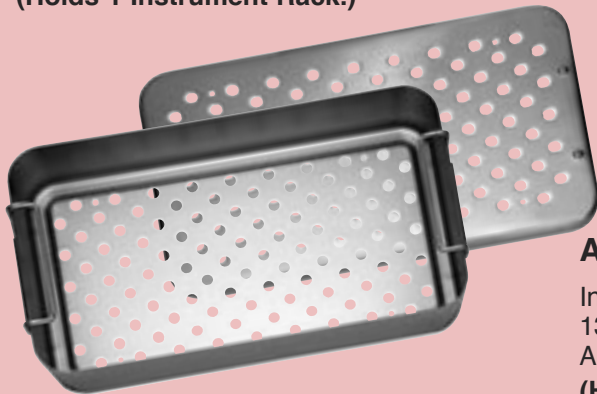

ASSI.ICH1323

Instrument case **without Instrument Rack**,
13 x 23 x 5cm, holds 16 instruments. Accepts any 2 of the following
ASSI® Instrument Racks: ICI15CB, ICI18, ICI53CB, or ICI15.
(Holds 2 Instrument Racks tiered one above the other.)

ACCURATE SURGICAL & SCIENTIFIC INSTRUMENTS CORPORATION

300 SHAMES DRIVE, WESTBURY, NY 11590, TEL: 516-333-2570 • FAX: 1-516-997-4948 • WEST COAST SALES: SAN DIEGO, CA: 619-296-9945
Info: assi@accuratesurgical.com • Orders: orders@accuratesurgical.com • www accuratesurgical.com

Instrument Racks

INSTRUMENT RACKS

Our instrument racks are designed to fit interchangeably into the range of instrument cases on page 11. They differ with regard to the length of instruments held.

The holding bars are of high grade silicone rubber with slots and holes for the firm fixation of each instrument. The instruments are securely held, yet can be easily removed when needed.

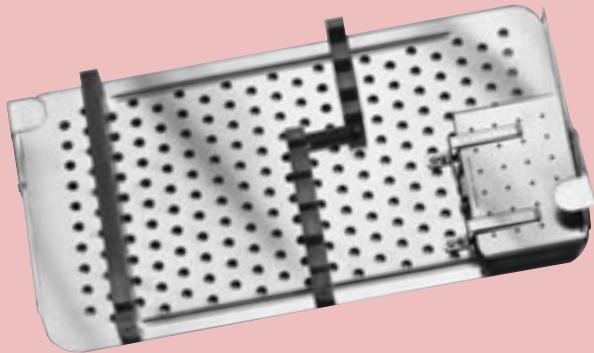

ASSI.ICI53CB

Rack for 5 instruments up to 15cm length plus 3 instruments up to 18cm length, **with** 1 CB1 (clamp box).

(Holds 8 instruments)

ASSI.ICI53

Rack for 5 instruments up to 15cm length plus 3 instruments up to 18cm length, **without** 1 CB1 (clamp box).

(Holds 8 instruments)

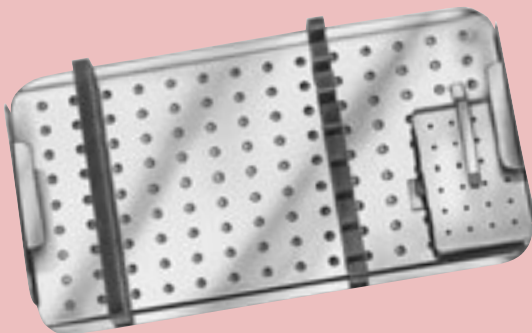

ASSI.ICI18CB

Rack for 8 instruments from 15-18cm length, **with** CB1 (clamp box).

(Holds 8 instruments)

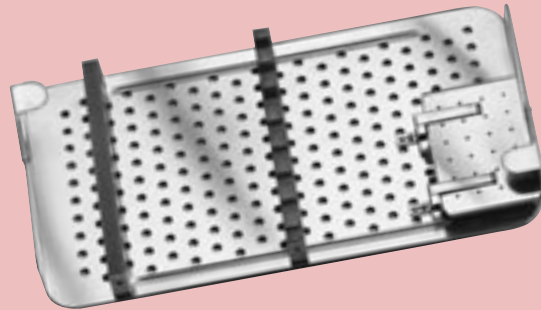

ASSI.ICI15CB

Rack for 8 instruments from 9-15cm length, **with** 1 CB1 (clamp box).

(Holds 8 instruments)

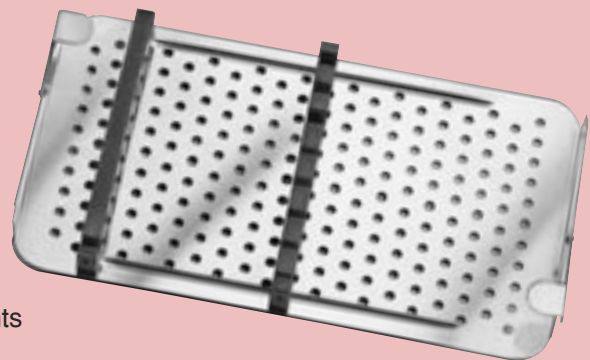

ASSI.ICI15

Rack for 8 instruments from 9-15cm length **without** CB1 (clamp box).

(Holds 8 instruments)

ASSI.ICI18

Rack for 8 instruments from 15-18cm length, **without** CB1 (clamp box).

(Holds 8 instruments)

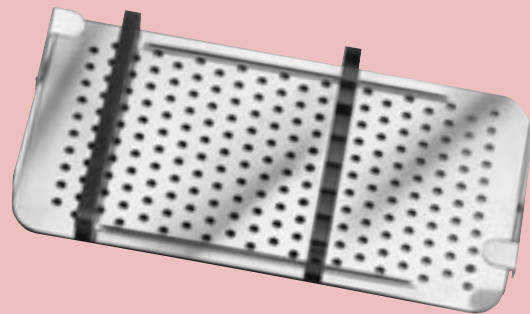

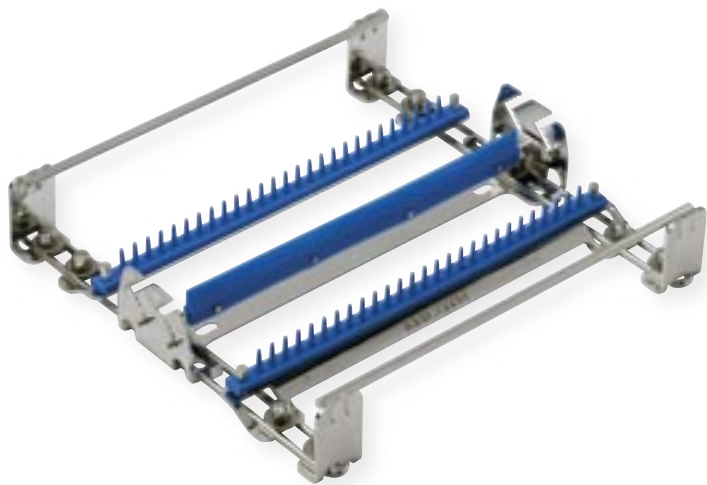

ASSI.72257

Rack for Bipolar Forceps/Bipolar Scissors
2 finger & 1 clamping bar
Small, 23cm x 22cm

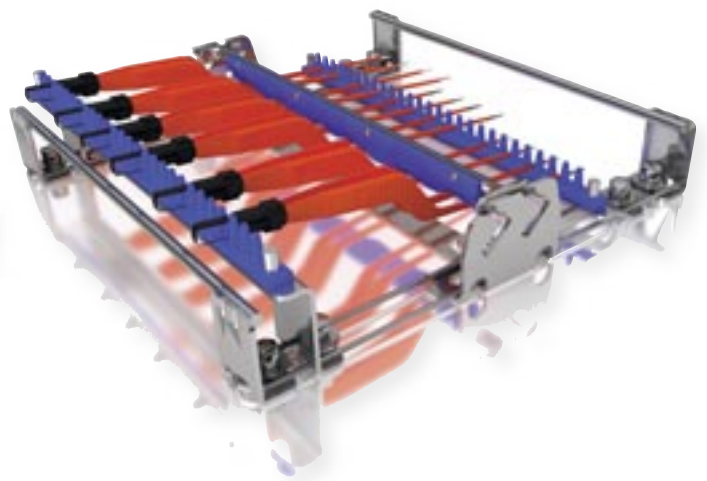

ASSI.72259

Rack for Bayonet Bipolar Forceps
2 finger & 1 clamping bar
Large, 25cm x 25cm
(Bayonet Forceps shown but sold separately)

ASSI® Baskets

ASSI.72265

Basket w/handles
(For ASSI.72257 & 72259 Racks) 24cm x 25cm x 7cm SS

ASSI.72266

Lid
(For Basket ASSI.72265) 24cm x 25cm SS

ASSI.72267

Basket w/handles
(For ASSI.72260, 72261 & 72262 Racks) 48cm x 25cm x 7cm SS

ASSI.72268

Lid
(For Basket ASSI.72267) 48cm x 25cm SS

ASSI.72269

Basket w/handles
54cm x 25cm x 6cm

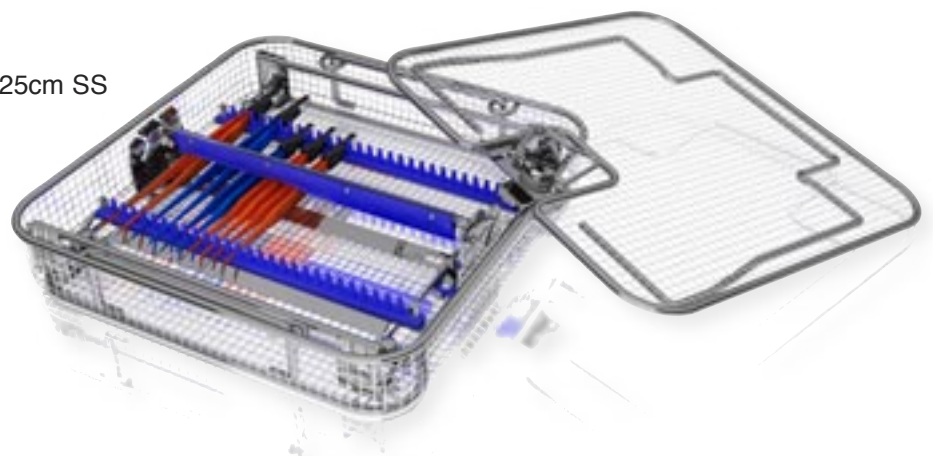

(Rack and forceps shown but sold separately)

Instrument Racks

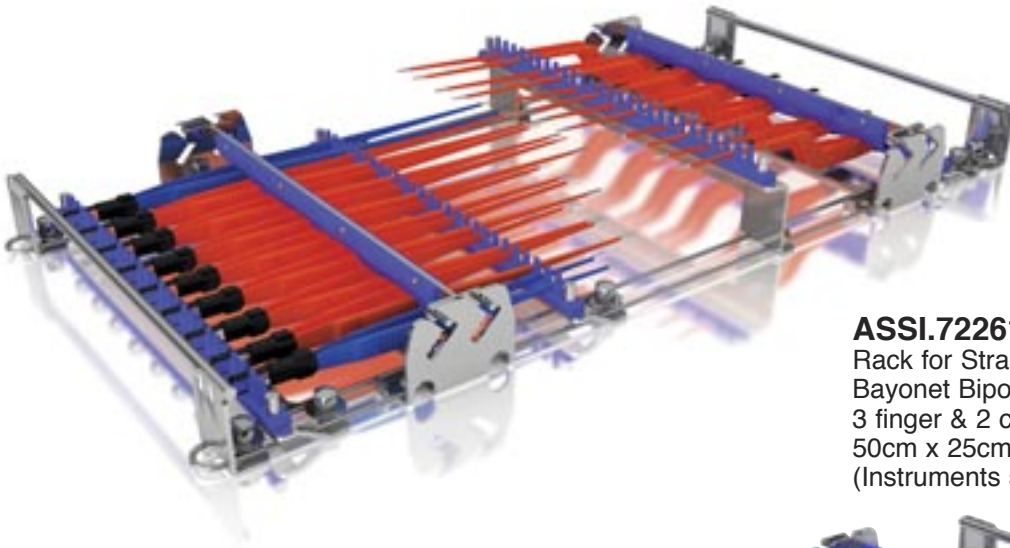

ASSI.72261
Rack for Straight &
Bayonet Bipolar Forceps
3 finger & 2 clamping bars
50cm x 25cm
(Instruments shown but sold separately)

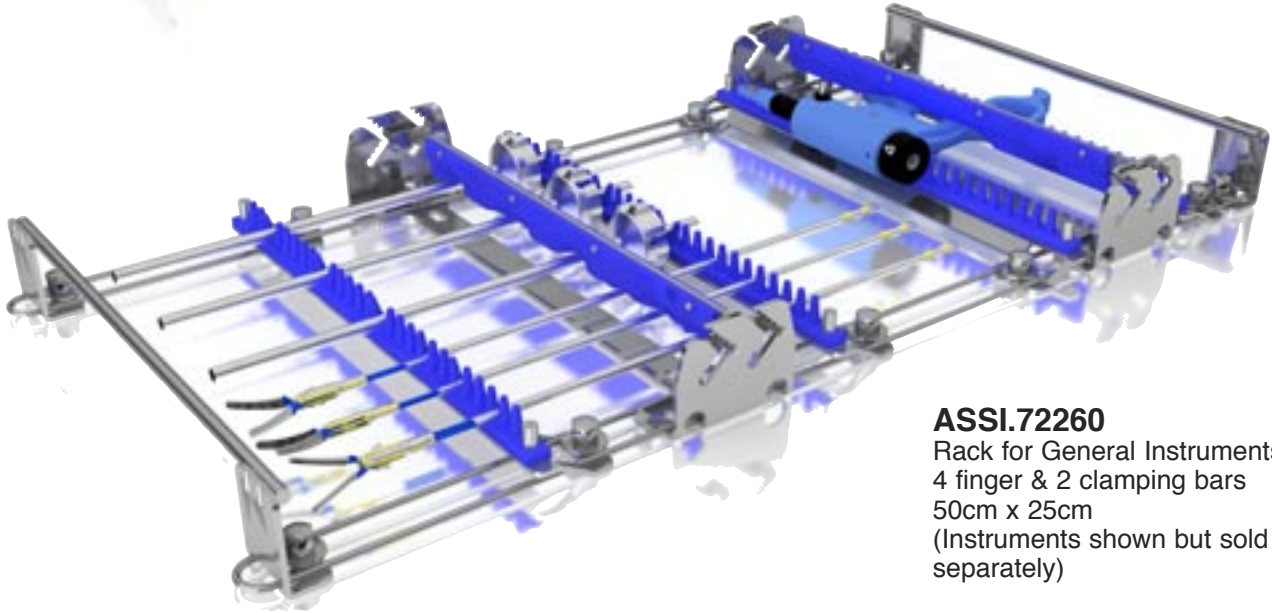

ASSI.72260
Rack for General Instruments
4 finger & 2 clamping bars
50cm x 25cm
(Instruments shown but sold separately)

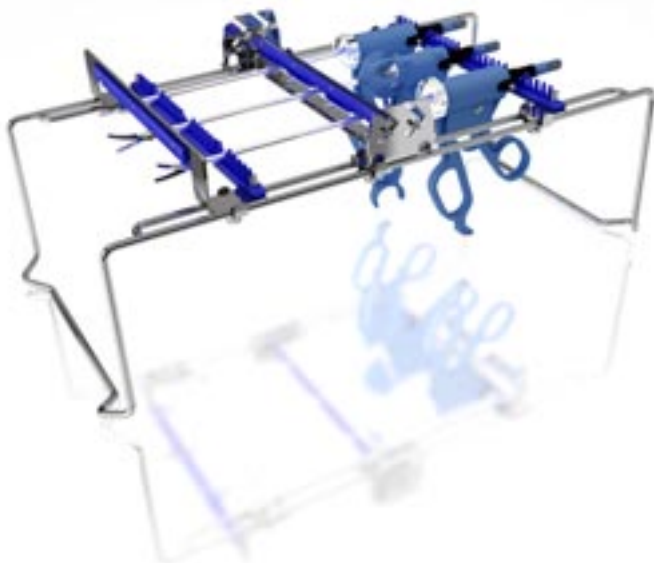

ASSI® Racks

ASSI.72262
for Instruments with Long Shafts
(For Detachable Handle Instruments)
2 finger & 1 clamping bar
51cm
(Instruments shown but sold separately)

Instrument Racks

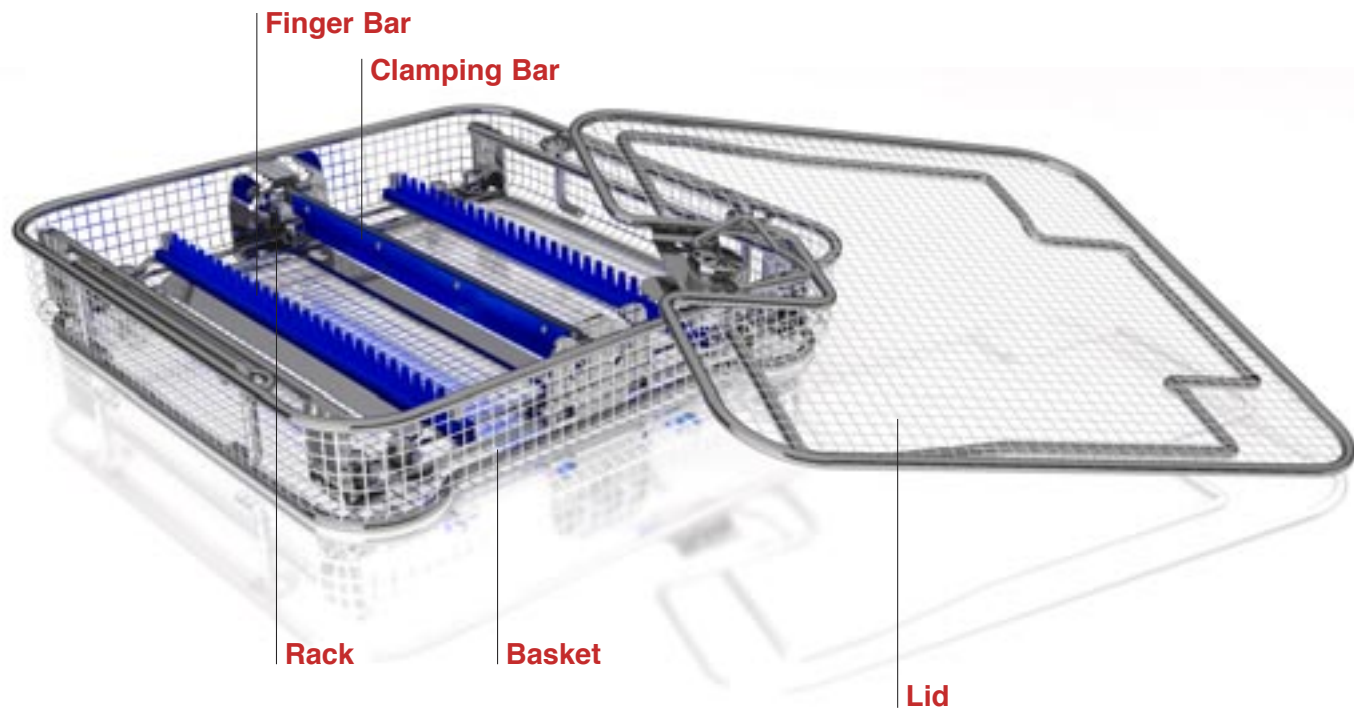

ASSI® Racks

ASSI.72257

Rack for Bipolar Forceps/Bipolar Scissors
2 finger & 1 clamping bar, **Small**, 23cm x 22cm

ASSI.72259

Rack for Bayonet Bipolar Forceps
2 finger & 1 clamping bar, **Large**, 25cm x 25cm

ASSI.72260

Rack for General Instruments
4 finger & 2 clamping bars, 50cm x 25cm

ASSI.72261

Rack for Straight & Bayonet Bipolar Forceps
3 finger & 2 clamping bars, 50cm x 25cm

ASSI.72262

for Instruments with Long Shafts
(For Detachable Handle Instruments)
2 finger & 1 clamping bar, 51cm

ASSI® Baskets

ASSI.72265

Basket w/handles
(For ASSI.72257 & 72259 Racks) 24cm x 25cm x 7cm SS

ASSI.72266

Lid
(For Basket ASSI.72265) 24cm x 25cm SS

ASSI.72267

Basket w/handles
(For ASSI.72260, 72261 & 72262 Racks)
48cm x 25cm x 7cm SS

ASSI.72268

Lid
(For Basket ASSI.72267) 48cm x 25cm SS

ASSI.72269

Basket w/handles
54cm x 25cm x 6cm



ASSI.NBPPC46
Ultra Soft Polishing Cloth
Two Cloth System in 1

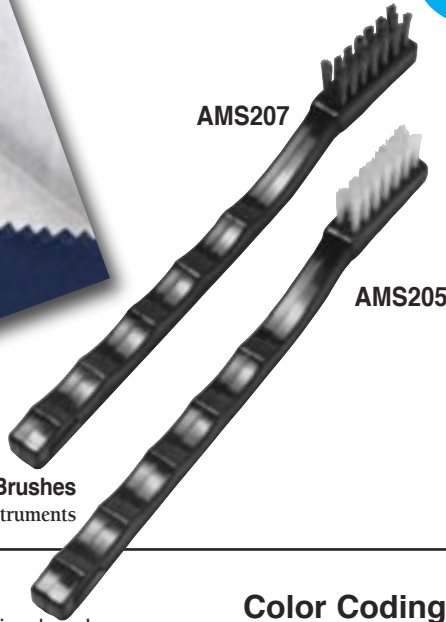

Cleaning Brushes
for Large surgical instruments

ALL COLORS

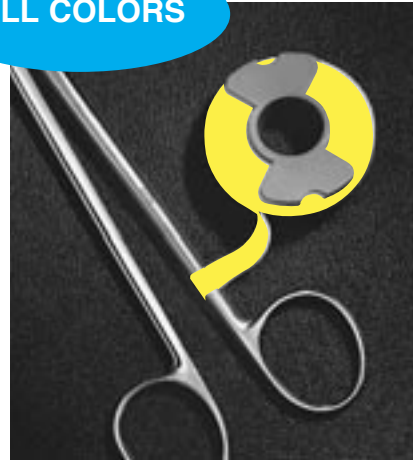

Color Coding Tape
For Surgical Instruments

Cleaning Brushes

AMS207 Stainless steel bristle cleaning brush
AMS205 Nylon bristle cleaning brush

ASSI.NBPPC46

Polishing Cloth System may be used to remove oxidation from the Noble™ Metal Tip.

Color Coding Tape for Surgical Instruments

Catalog No.	Color
ASSI.823	Green
ASSI.825	Yellow
ASSI.827	Blue

Catalog No.	Color
ASSI.829	Red
ASSI.831	Brown
ASSI.833	White
ASSI.835	Orange
ASSI.837	Black
ASSI.839	Purple

VENTED AND NON-VENTED SIZES AND COLORS

NON-VENTED											
ATC000	ATC100	ATC110	ATC111	ATC112	ATC113	ATC114	ATC115	ATC116	ATC117	ATC111-L	
VENTED											
ATC000-V	ATC100-V	ATC110-V	ATC111-V	ATC112-V	ATC113-V	ATC114-V	ATC115-V	ATC116-V	Sold separately 100 piece pkgs.		
WHITE	BLUE	GREEN	RED	YELLOW	CLEAR	MAROON	ORANGE	BROWN	BLACK	BLUE4	RED
											Not available in vented

Now Available Non-vented or Vented
100 pieces per pack

Note: Not all ASSI products shown in our literature or on our website are available for sale in Canada.

accurate surgical & scientific instruments corporation

ACCURATE SURGICAL & SCIENTIFIC INSTRUMENTS CORPORATION

300 SHAMES DRIVE, WESTBURY, NY 11590, TEL: 516-333-2570 • FAX: 1-516-997-4948 • WEST COAST SALES: SAN DIEGO, CA: 619-296-9945

1-800-645-3569 (NEW YORK OFFICE)

1-800-255-9378 (WEST COAST OFFICE)